

Merilo: Scale:	1 : 20	Merilna Dolžina Location	= - + -
9 160 29452 531 0		ISKRYN SHEET 1	

CR4V12-Vzz ; p=160mm

**TSN** TOVARNIA STIKALNIH NAPRAV  
SWITCHGEAR MANUFACTURER  
Serijska c. 49, 2000 Maribor, SLOVENIJA  
tel./fax : +386 (0)2 228 66 00 / 252 50 05  
E-mail: tsn@tsn.si

VODNA CELICA  
DOVODNA CELICA  
INCOMING CUBICLE

Approved	Potrdil	Nedoh Z.	
Checked	Pregledal	Nedoh Z.	
Made	Izdelal	Nedoh Z.	
Date	Date	2007	

DA UN DATE	IME NAME



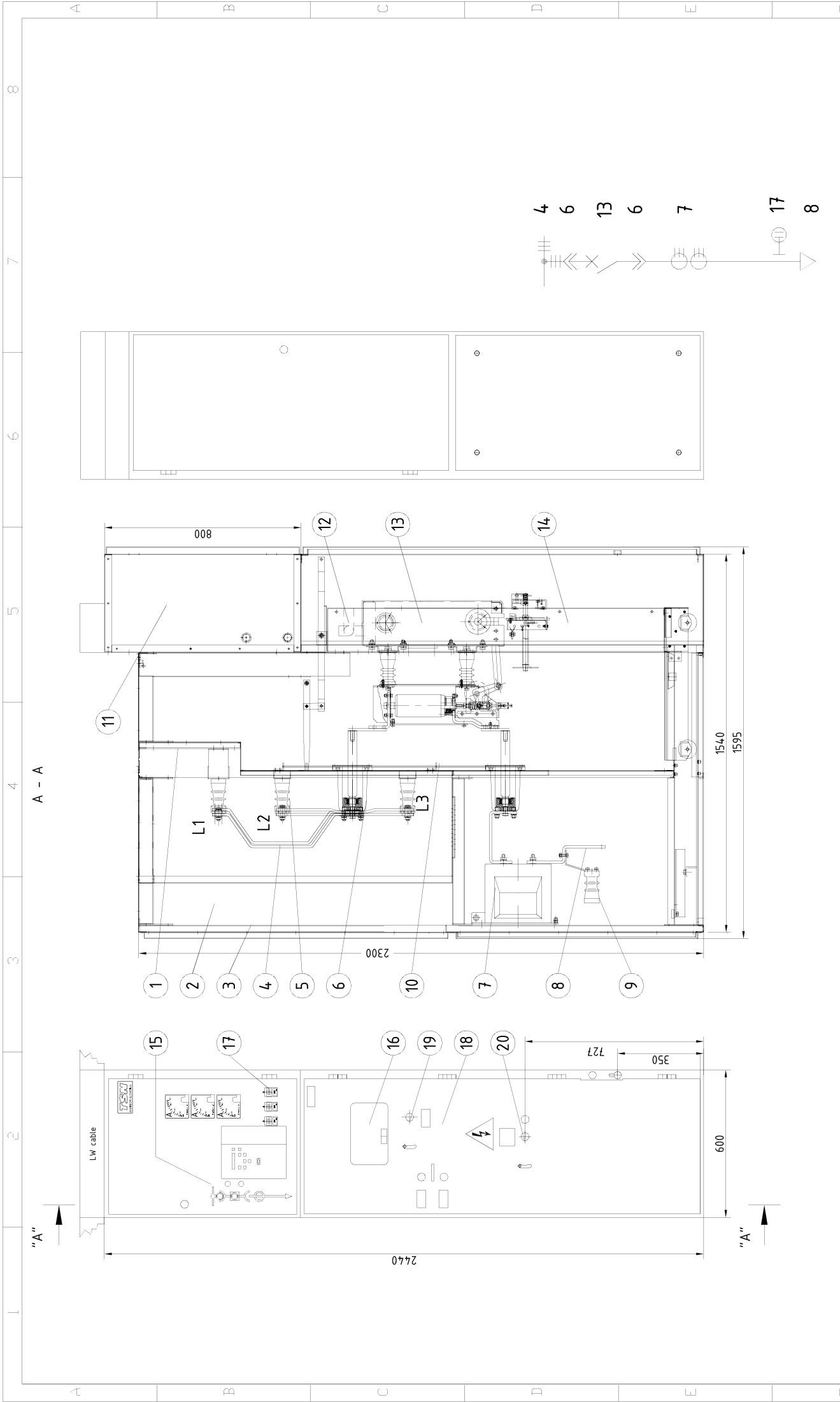

STAVBA / STATE	SPREMEMBA / REVISION	DA / ON / DATE	IME / NAME	Approved	Potrdil / Pregledal / Made	Nedoh Z. / Nedoh Z. / Nedoh Z. / 2007	 Approved / Checked / Made / Date	TOVARNA STIKALNIH NAPRAV <b>TSN</b> SWITCHGEAR MANUFACTURER Senjiška c. 49, 2000 Maribor, SLOVENIJA tel. / fax : + 386 (0)2 228 66 00 / 252 50 05 E-mail: tsn@tsn.si	Merilo: 1 : 20 Skala: = - Lokacija: + - 9 160 29452 531 2	Merilo: 1 : 20 Skala: = - Lokacija: + - 9 160 29452 531 2	7 8	6 7 8	5 6 7 8	4 5 6 7 8	3 4 5 6 7 8	2 3 4 5 6 7 8	1 2 3 4 5 6 7 8	TRANSFORMATORSKA ČELICA TRANSFORMATORSKA ČELIJA TRANSFORMER CUBICLE	CR4V12-T ; p=160mm	Merilo: 1 : 20 Skala: = - Lokacija: + - 9 160 29452 531 2	Merilo: 1 : 20 Skala: = - Lokacija: + - 9 160 29452 531 2	7 8	6 7 8	5 6 7 8	4 5 6 7 8	3 4 5 6 7 8	2 3 4 5 6 7 8	1 2 3 4 5 6 7 8
----------------	----------------------	----------------	------------	----------	----------------------------	---------------------------------------	---	---	--	--	--------	-------------	------------------	-----------------------	----------------------------	---------------------------------	--------------------------------------	---	--------------------	--	--	--------	-------------	------------------	-----------------------	----------------------------	---------------------------------	--------------------------------------



1 2 3 4 5 6 7 8

A - A

"A"

A B C D E F

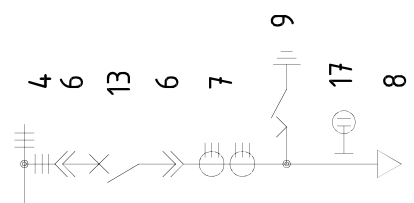
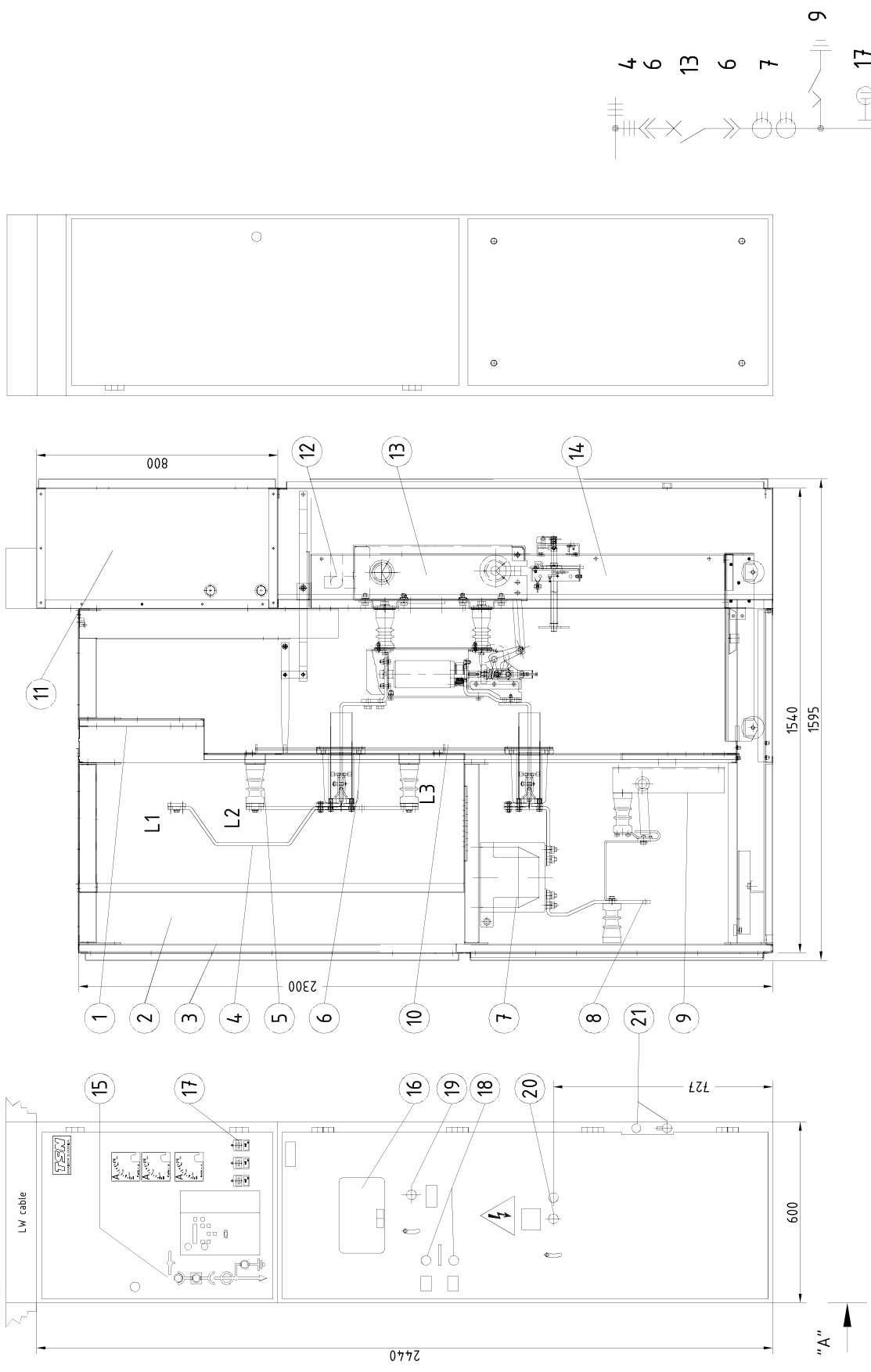

<table border="1"> <tr> <td>STRANJE</td> <td>DATE</td> <td>DA UN</td> <td>DATE</td> <td>IME</td> <td>NAME</td> </tr> <tr> <td>STATE</td> <td>REVISION</td> <td>DATE</td> <td>DATE</td> <td>NAME</td> <td>NAME</td> </tr> </table>	STRANJE	DATE	DA UN	DATE	IME	NAME	STATE	REVISION	DATE	DATE	NAME	NAME	<table border="1"> <tr> <td>Approved</td> <td>Potrdili</td> <td>Nedoh Z.</td> <td></td> </tr> <tr> <td>Checked</td> <td>Pregledal</td> <td>Nedoh Z.</td> <td></td> </tr> <tr> <td>Made</td> <td>Izdelal</td> <td>Nedoh Z.</td> <td></td> </tr> <tr> <td>Date</td> <td>Datum</td> <td>2007</td> <td></td> </tr> </table>	Approved	Potrdili	Nedoh Z.		Checked	Pregledal	Nedoh Z.		Made	Izdelal	Nedoh Z.		Date	Datum	2007		<p>VODNA CELICA DOVODNA CELICA INCOMING CUBICLE</p>	<p><b>FSN</b> TOVARNA STIKALNIH NAPRAV SWITCHGEAR MANUFACTURER Senjska c. 49, 2000 Maribor, SLOVENIA tel./fax: +386 (0)2 228 66 00 / 252 50 05 E-mail: fsm@fsm.si</p>	<p>CR4 V12-Vz ; p=160mm</p>	<p>Merilo: 1:20 Skala: - / +</p>	<p>Merilo: 1:20 Skala: - / +</p>	<p>9 160 29452 531 3</p>	<p>1 1</p>
STRANJE	DATE	DA UN	DATE	IME	NAME																															
STATE	REVISION	DATE	DATE	NAME	NAME																															
Approved	Potrdili	Nedoh Z.																																		
Checked	Pregledal	Nedoh Z.																																		
Made	Izdelal	Nedoh Z.																																		
Date	Datum	2007																																		







"A"

A - A

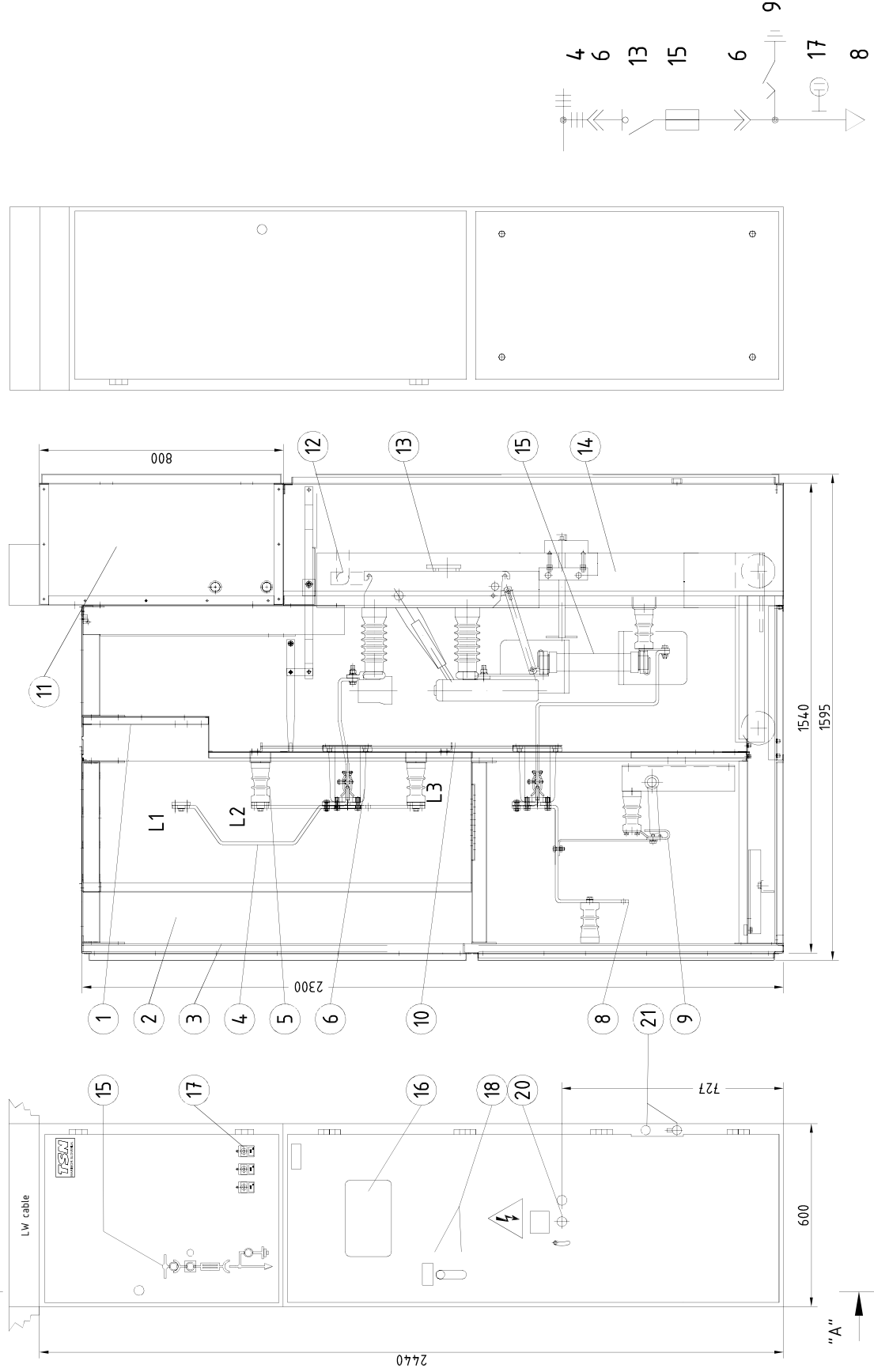

STAVBA	SPREMEMBA	DA/UN	DATE	IME	NAME

Approved	Potrdil	Nedoh Z.	2007
Checked	Pregledal	Nedoh Z.	
Made	Izdelal	Nedoh Z.	
Date	Date		

CELICA LASTNE RABE  
 ČELIJA VLASTITE POTROŠNJE  
 AUXILIARY TRANSFORMER CUBICLE

**TSN** TOVARNA STIKALNIH NAPRAV  
 SWITCHGEAR MANUFACTURER  
 Šentjaska c. 49, 2000 Maribor, SLOVENIJA  
 tel./fax: +386 (0)2 228 66 00 / 252 50 05  
 E-mail: tsn@tsn.si

Model: 1 : 20  
 Scale: 1 : 20  
 Číslo: 9 160 29452 531 6  
 Číslo: 9 160 29452 531 6



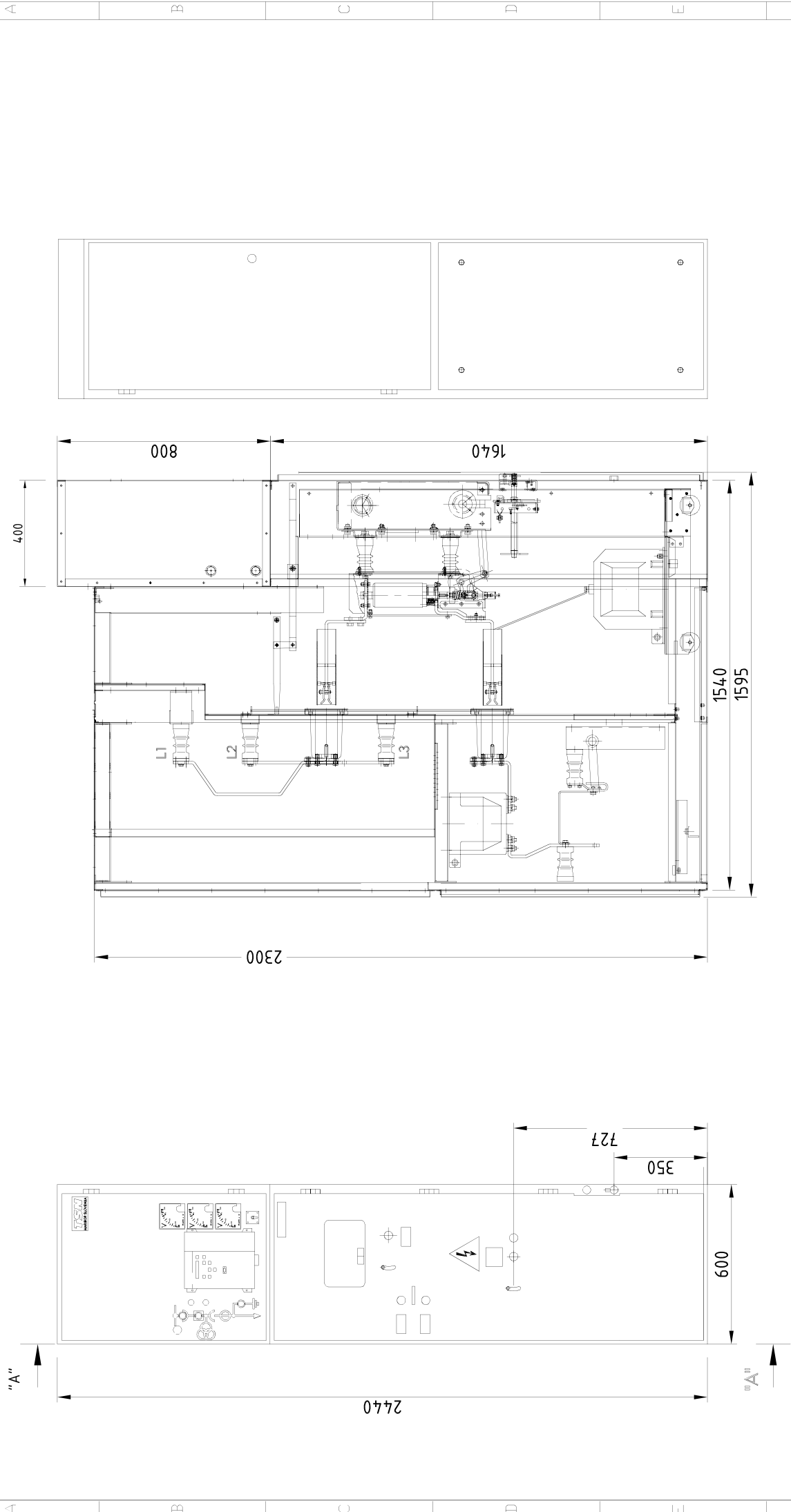

STAVBA / STATE	SPREMEMBA / REVISION	DAJUN / DATE	IME / NAME	2007	2007	2007	2007
Approved	Potrdili / Checked	Pogledal / Made	Neodoh Z. / Date	Neodoh Z. / 2007	Neodoh Z. / 2007	Neodoh Z. / 2007	Neodoh Z. / 2007
				<b>VODNA CELICA</b> <b>DOVODNA CELICA</b> <b>INCOMING CUBICLE</b>			
				<b>TSN</b> TOVARNA STIKALNIH NAPRAV SWITCHGEAR MANUFACTURER Senjska c. 49, 2000 Maribor, SLOVENIJA tel. / fax : + 386 (0)2 228 66 00 / 252 50 05 E-mail: tsn@tsn.si			
				CR4V12-Vzm ; p=160mm			
				Merilo: 1:20 Skala: 9 160 29452 531 9			
				Merilo: 1:20 Skala: 9 160 29452 531 9			
				Merilo: 1:20 Skala: 9 160 29452 531 9			



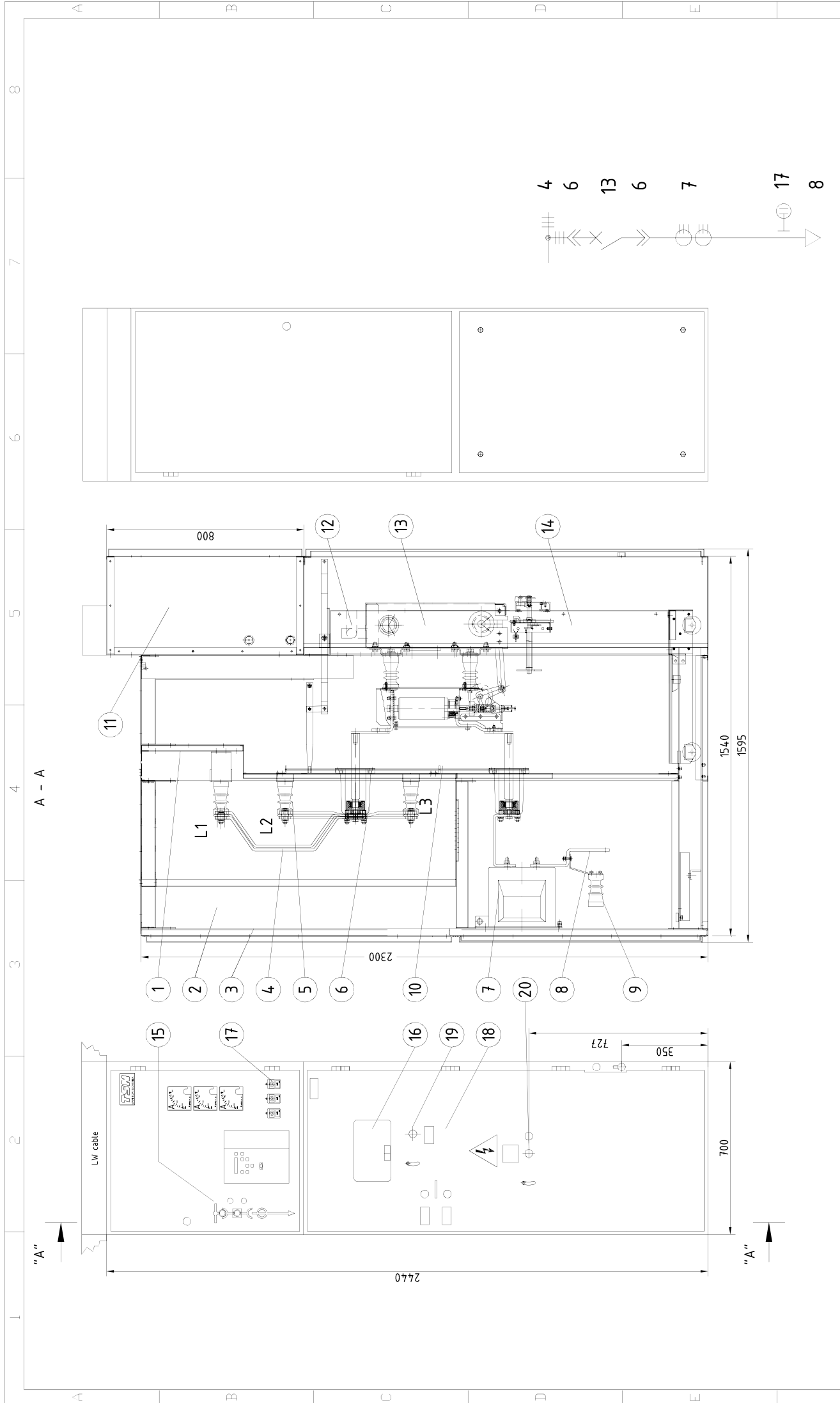

STAVBA / STATE	SPREMEMBA / REVISION	DATE / DATE	IME / NAME	2	3	4	5	6	7	8	
Approved	Potrtil / Checked	Nedoh Z. / Made	2007								
	Pregledal / Made	Nedoh Z. / Date									
	Izdelal / Date	Nedoh Z. / Date									
<p><b>TSN</b> TOVARNA STIKALNIH NAPRAV SWITCHGEAR MANUFACTURER Serijska c. 49, 2000 Maribor, SLOVENIJA tel. / fax : + 386 (0)2 228 66 00 / 252 50 05 E-mail: tsn@tsn.si</p>				<p>TRANSFORMATORSKA CELICA TRANSFORMATORSKA ČELIJA TRANSFORMER CUBICLE</p>				<p>CR4V12-T ; p=160mm</p>			
<p>Merilo: 1:20 Skala: = - Lokacija: +</p>				<p>9 160 29452 551 2</p>				<p>TSN SHEET TOP 1</p>			





















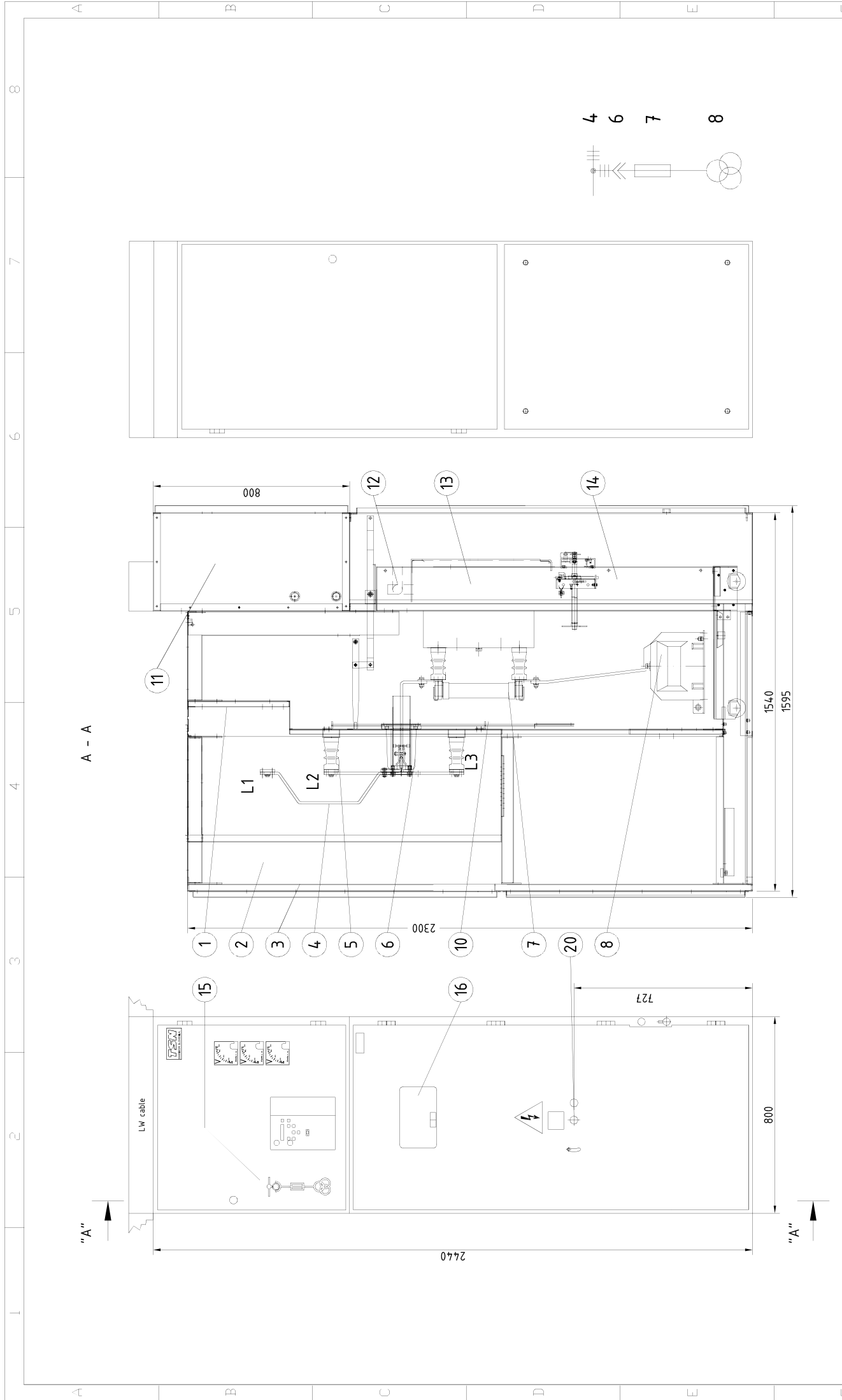

STAVBA STATE	SPREMEMBA REVISION	DAVILNIK DATE	IME NAME	Approved	Potrjeli Checked	Nedoh Z. Nedoh Z.	2007	<b>MERILNA CELICA</b> <b>MJERNA CELIJA</b> <b>METERING CUBICLE</b>		<b>TSN</b> TOVARNNA STIKALNIH NAPRAV SWITCHGEAR MANUFACTURER Seniljska c. 49, 2000 Maribor, SLOVENIJA tel./fax: +386 (0)2 228 66 00 / 252 50 05 E-mail: tsn@tsn.si	Merilo: Scale:	1 : 20	Merilo: Scale:	9 160 29452 561 1	= - = + Location	1 1 1
-----------------	-----------------------	------------------	-------------	----------	---------------------	----------------------	------	--	--	---	-------------------	--------	-------------------	-------------------	------------------------	-------------

CR4V12-M ; p=210mm



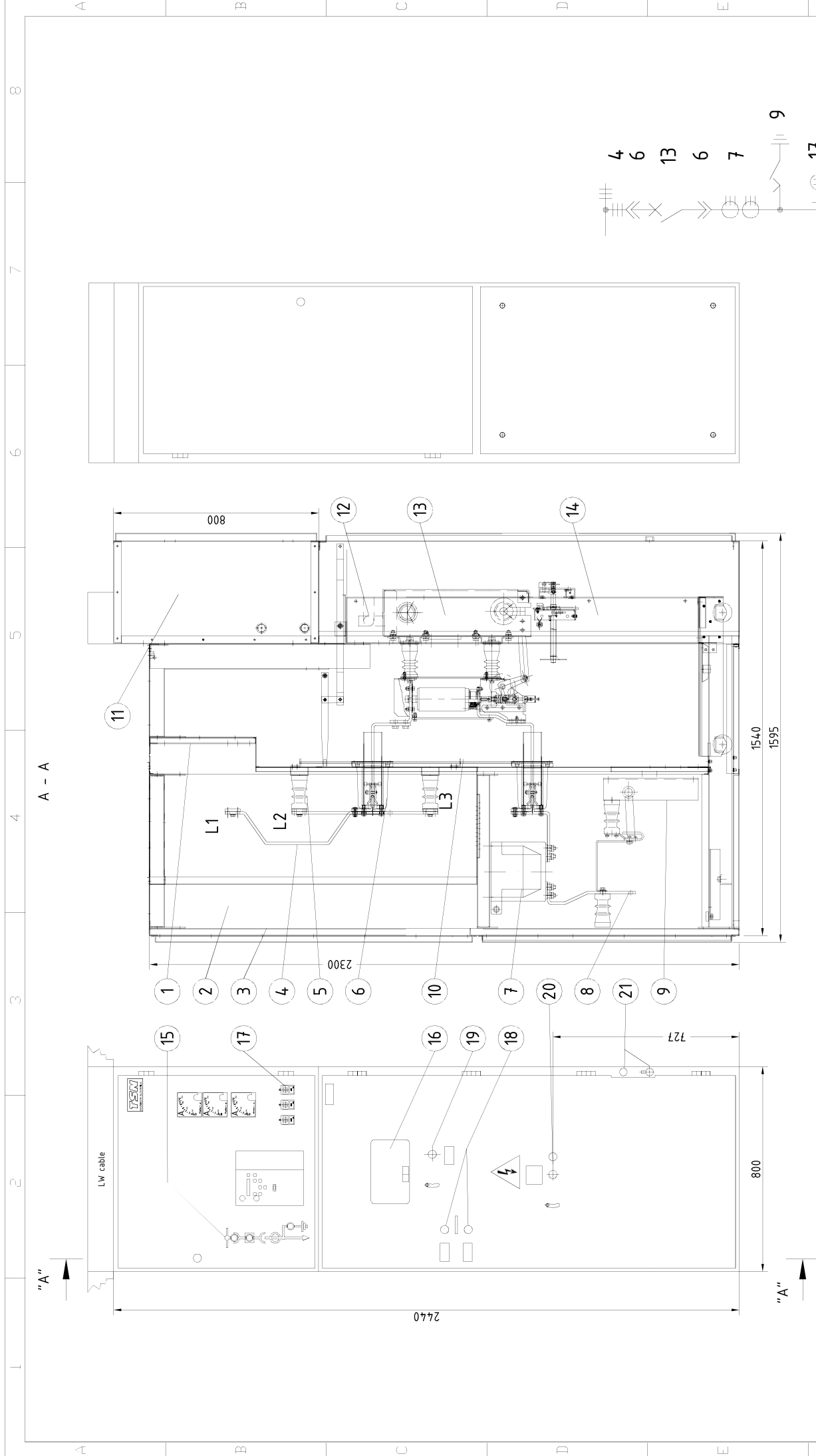

STRANICA / STATE	SPREJEMBA / REVISION	DAYUM / DATE	IME / NAME	Approved	Potrtili / Checked	Nedoh Z. / Made	2007	3	4	5	6	7	8
<p>VODNA CELICA DOVODNA CELICA INCOMING CUBICLE</p>								<p><b>TSN</b> TOVARNA STIKALNIH NAPRAV SWITCHGEAR MANUFACTURER Senjalska c. 49, 2000 Maribor, SLOVENIJA tel./fax: +386 (0)2 228 66 00 / 252 50 05 E-mail: tsn@tsn.si</p>					
<p>CR4 V12-Vz ; p=210mm</p>										<p>Merilo: 1:20 Skala: - / +</p>		<p>Merilo: 1:20 Skala: - / +</p>	
<p>9 160 29452 561 3</p>										<p>9 160 29452 561 3</p>		<p>1 1</p>	



















NAJMANJŠA RAZDALJA DO STENE S STRANI 50 mm  
MINIMUM DISTANCE TO THE WALL FROM THE SIDE 50 mm

KANAL  
CABLE TRAY

OZEMLJITEV  
EARTHING

2 KABLA/ FAZO  
TWO CABLES/ F.

1 KABEL/ FAZO  
ONE CABLE/ F.

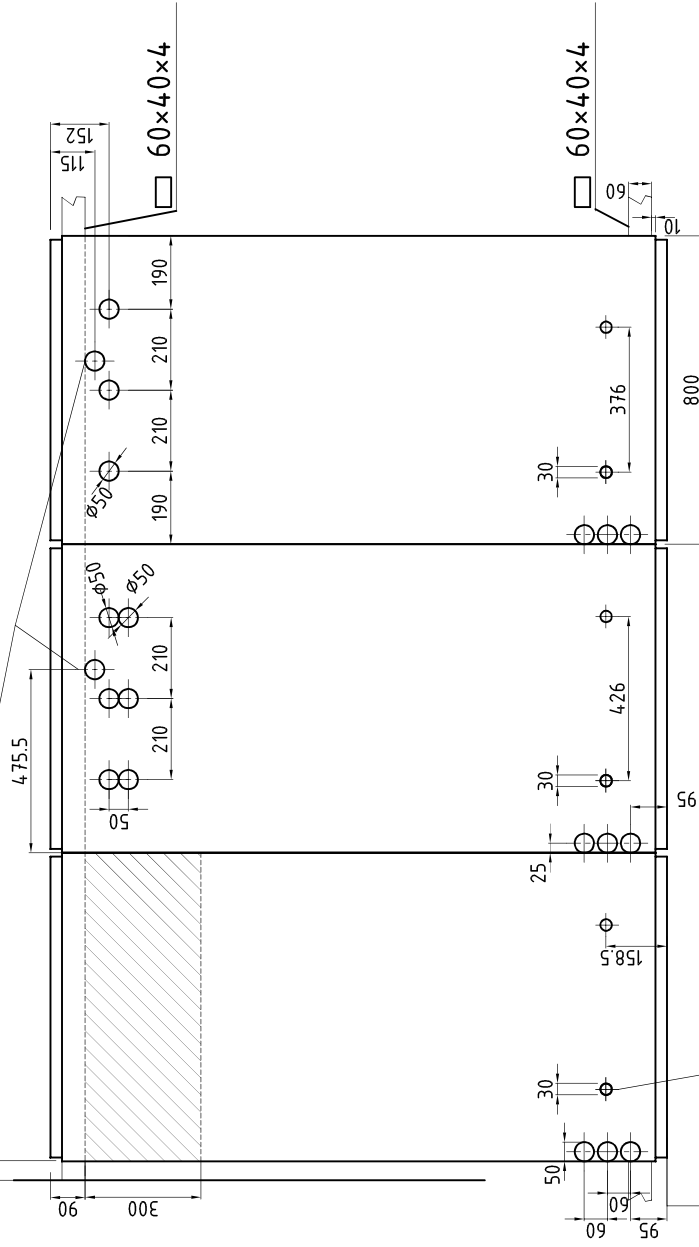

SIDERNI VLOŽEK ZA VIJAK M 12 x 40  
SCREW ANCHOR FOR SCREW M 12 x 40

ŠIRINA MANIPULACIJSKEGA HODNIKA JE MIN. 1300 mm, PRIPOROČENO 1500 mm  
WIDTH OF MANIPULATION CORRIDOR MIN. 1300 mm, RECOMMENDED 1500 mm

ZADNJA STENA  
REAR WALL

VRATA  
DOOR

1600

60x40x4

14.10

1530

60

10

DETAIL "A"  
DETAIL "A"

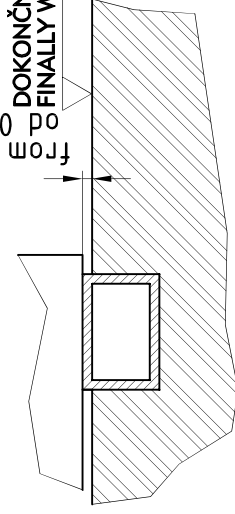

DOKONČNO OBDELANA TLA  
FINALLY WORKED-OUT FLOOR

Sprememba / Revision	1
----------------------	---

Obdelal / Made	Z. Nedoh
Pregl. / Check	Z. Nedoh
Odobril / Appr.	Radko Krivec
Datum / Date	IX/04

TALNE ODPRTINE  
FLOOR OPENINGS

**TSN** SLOVENIJA  
Maribor, Semtijska 49

Iz vlečljiva celica CR4V 12  
Withdrawable panel CR4V 12

Merilo  
Scale 1 : 20

4 060 00031 999 1

List Sh.  
Listov / Shrs. 1 1

NAJMANJŠA RAZDALJA DO STENE S STRANI 50 mm  
MINIMUM DISTANCE TO THE WALL FROM THE SIDE 50 mm

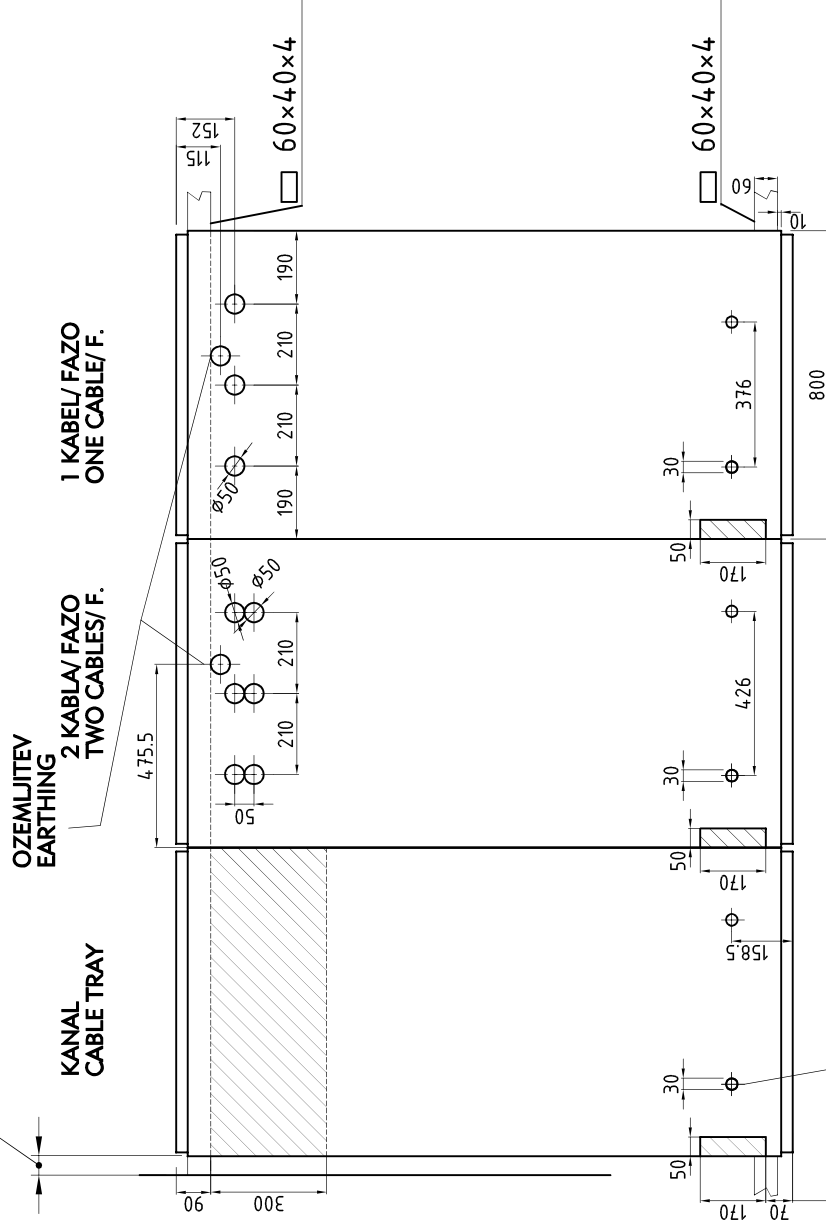

SIDERNI VLOŽEK ZA VIJAK M 12 x 40  
SCREW ANCHOR FOR SCREW M 12 x 40

ŠIRINA MANIPULACIJSKEGA HODNIKA JE MIN. 1300 mm, PRIPOROČENO 1500 mm  
WIDTH OF MANIPULATION CORRIDOR MIN. 1300 mm, RECOMMENDED 1500 mm

ZADNJA STENA  
REAR WALL

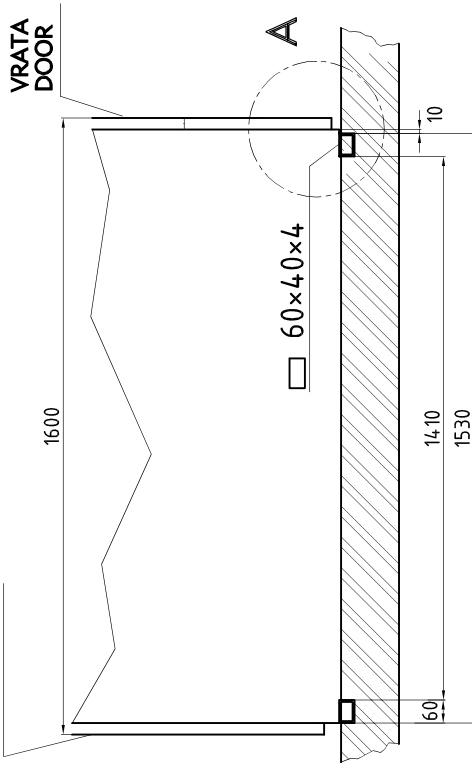

DETAIL "A"  
DETAIL "A"

DOKONČNO OBDELANA TLA  
FINALLY WORKED-OUT FLOOR

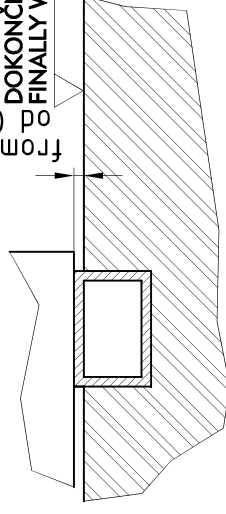

Sprememba / Revision	1
Obdelal / Made	Z. Nedoh
Pregl. / Check	Z. Nedoh
Odobril / Appr.	Radko Krivec
Datum / Date	IX/04

TALNE ODPRTINE  
FLOOR OPENINGS

**TSN** SLOVENIJA  
Maribor, Šentjurska 49

Iz vlečljiva celica CR4V 12  
Withdrawable panel CR4V 12

Merilo  
Scale 1 : 20

4 060 00031 999 2  
List Sh. 1  
Listov / Shrs. 1

NAJMANJŠA RAZDALJIA DO STENE S STRANI 50 mm  
MINIMUM DISTANCE TO THE WALL FROM THE SIDE 50 mm

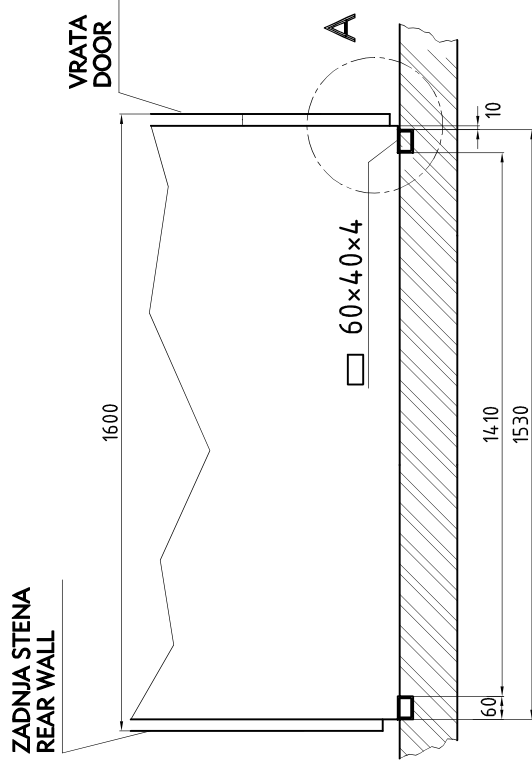
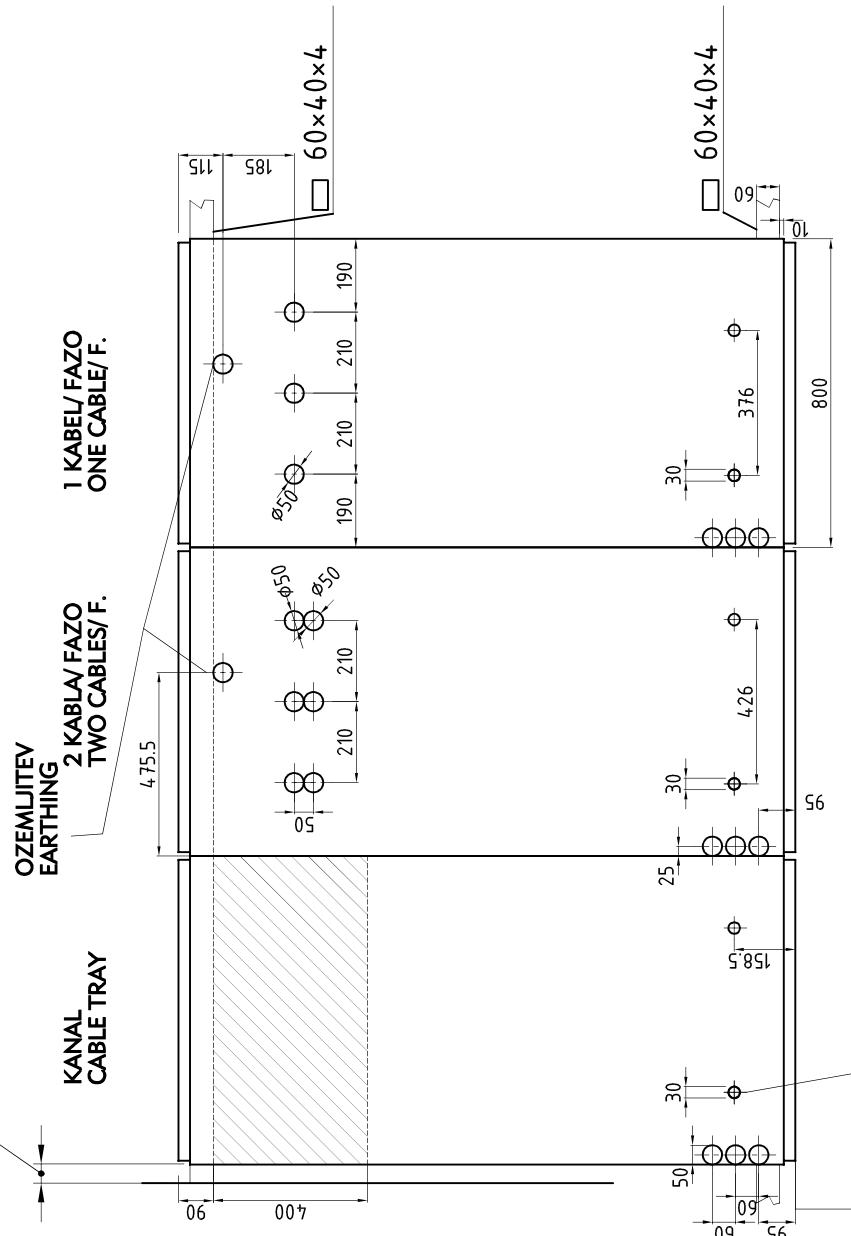

DETAIL "A"  
DETAIL "A"

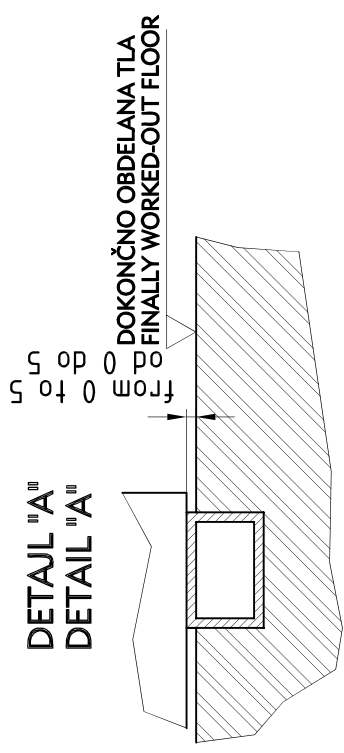

SIDERNI VLOŽEK ZA VIJAK M 12 x 40  
SCREW ANCHOR FOR SCREW M 12 x 40

ŠIRINA MANIPULACJSKEGA HODNIKA JE MIN. 1300 mm, PRIPOROČENO 1500 mm  
WIDTH OF MANIPULATION CORRIDOR MIN. 1300 mm, RECOMMENDED 1500 mm

Sprememba / Revision	1	2	3	4	5	6	7	8	
	Obdelal Pregl.	Made Check	Z. Nedoh Z. Nedoh	TALNE ODPRTINE FLOOR OPENINGS		Iz vlečljiva celica CR4V 12 Withdrawable panel CR4V 12		Merilo Scale	1 : 20
	Odobril Datum	Appr. Date	Radko Krivec IX/04	TSN SLOVENIJA Maribor, Šentjurska 49		4 060 00031 999 3		List Sh.	1
								Listov Shrs.	1







